

The Dilepton Probe from SIS to RHIC

Hendrik van Hees

Justus-Liebig Universität Gießen

May 13, 2011



**Institut für
Theoretische Physik**



- 1 Electromagnetic probes in heavy-ion collisions
- 2 Dileptons at SIS energies
- 3 Dileptons at SPS and RHIC
- 4 Conclusions

Electromagnetic probes in heavy-ion collisions

- γ, ℓ^\pm : no strong interactions
- reflect whole “history” of collision:
 - from pre-equilibrium phase
 - from thermalized medium
QGP and hot hadron gas
 - from VM decays after thermal freezeout

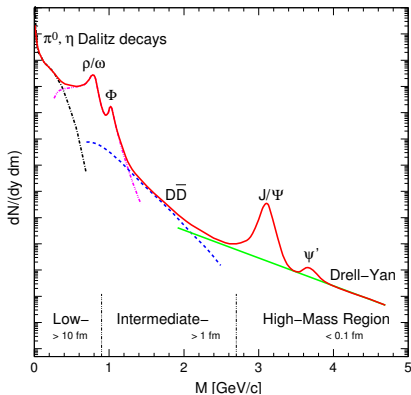
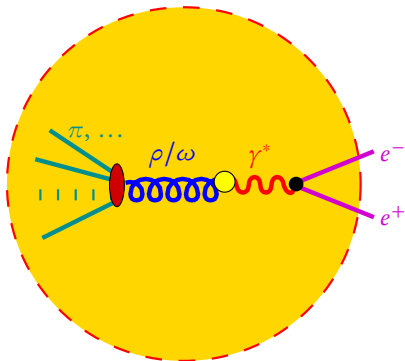

Fig. by A. Drees

Vector Mesons and electromagnetic Probes

- l^+l^- thermal emission rates \Leftrightarrow em. current-correlation function, $\Pi_{\mu\nu}$

[L. McLerran, T. Toimela 85, H. A. Weldon 90, C. Gale, J.I. Kapusta 91]

$$\frac{dN_{e^+e^-}}{d^4x d^4q} = -g^{\mu\nu} \frac{\alpha^2}{3q^2 \pi^3} \text{Im} \Pi_{\mu\nu}^{(\text{ret})}(q) \Big|_{q^2=M_{e^+e^-}^2} f_B(q_0)$$

- vector-meson dominance model:

$$\Pi_{\mu\nu} = \text{---} \gamma^* \text{---} G_\rho \text{---} \gamma^* \text{---}$$

- hadronic many-body theory for vector mesons

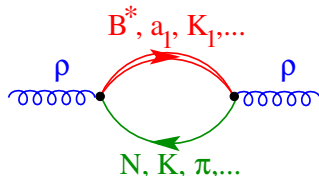
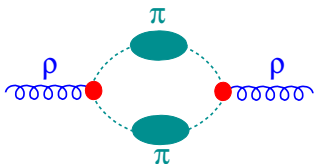

- elementary processes \Leftrightarrow cut self-energy diagrams

Relation to the QCD-phase diagram

- at high temperature/density: **restoration of chiral symmetry**
- Lattice QCD: $T_c^X \simeq T_c^{\text{deconf}}$

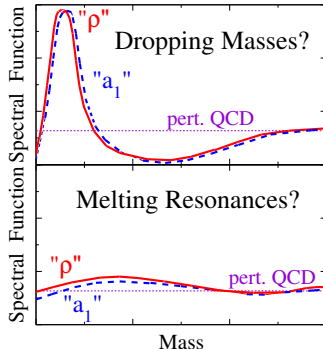
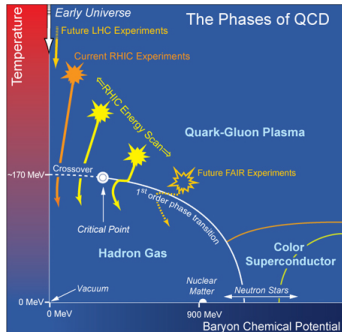

- **Mechanism** of chiral restoration?
- Two main theoretical ideas
 - "dropping masses": $m_{\text{had}} \propto \langle \bar{\psi}\psi \rangle$
 - "melting resonances": broadening of spectra through medium effects
 - **More theoretical question:** Realization of chiral symmetry in nature?

Finite Temperature/Density: Idealized theory picture

- partition sum: $Z(V, T, \mu_q, \Phi) = \text{Tr}\{\exp[-(\mathbf{H}[\Phi] - \mu_q \mathbf{N})/T]\}$

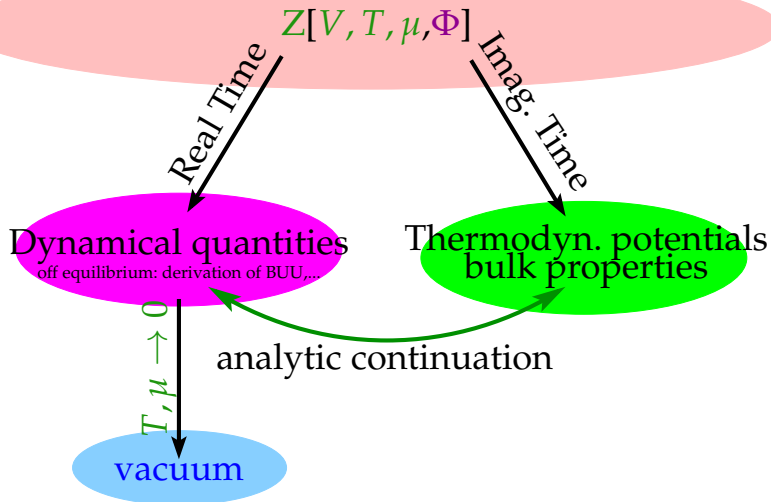

Dileptons at SIS energies

- dileptons from heavy-ion collisions at DLS at $E = 1A$ GeV
[Porter et al, PRL **79**, 1229 (1997)]
- large enhancement at low invariant masses unexplained
- DLS puzzle**

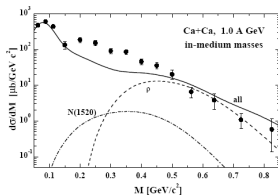

[Bratkovskaya et al (1999)]

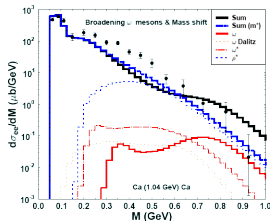

[Ernst et al (1998)]

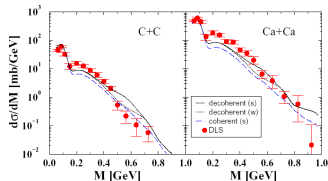

[Fuchs et al (2003)]

Experimental confirmation

- DLS measurement **confirmed** by HADES at GSI

[Sudol et al, EPJC **62**, 81 (2009)]

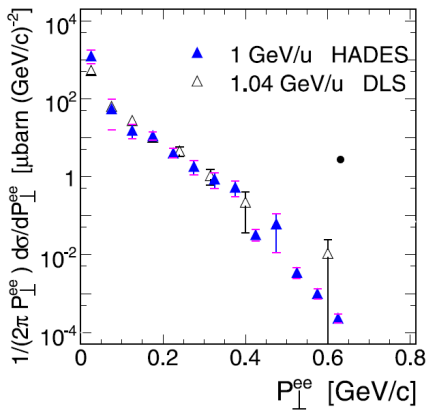
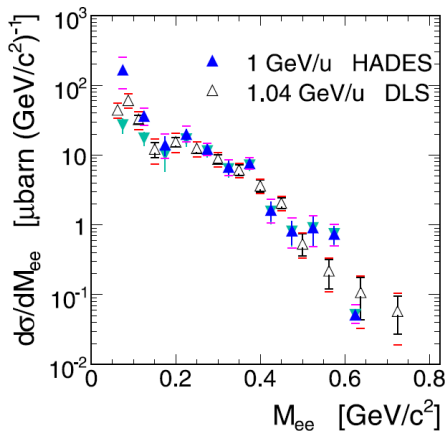

Theoretical "HADES Puzzle"

- one-boson-exchange model by Shyam/Mosel
- Bremsstrahlung in pp and pn collisions

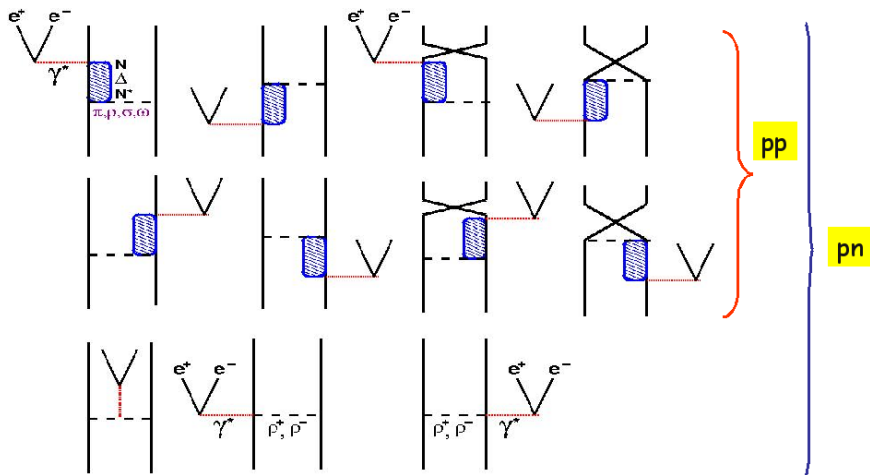

Theoretical “HADES Puzzle”

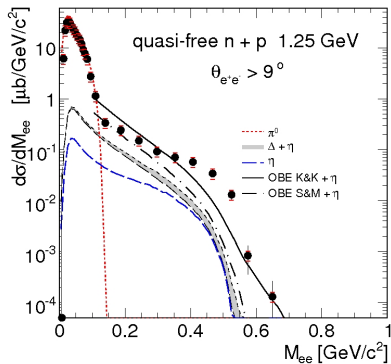
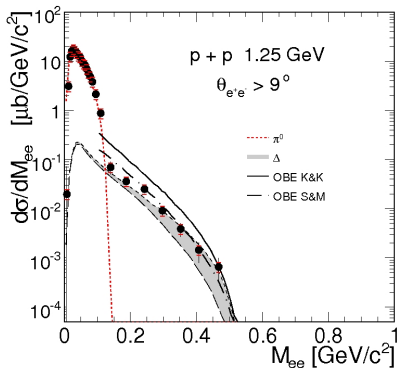

- elementary pp- and pn-cross sections
- discrepancy between models (KK vs. SM);
only difference: pseudo-scalar vs. pseudo-vector couplings
(should be on-shell equivalent!)
- discrepancy of between theory and experiment in pn bremsstrahlung

Most recent update

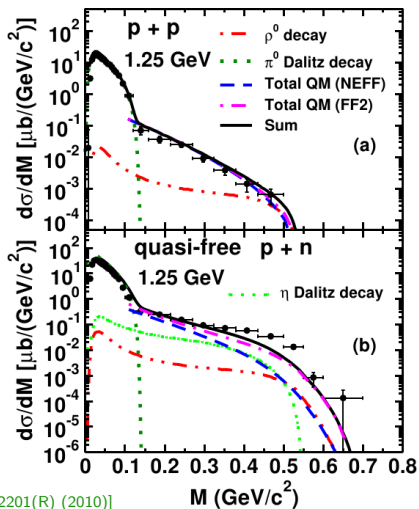

[R. Shyam, U. Mosel, PRC 82, 062201(R) (2010)]

- crucial for pn: **nucleon-** and **π -form factors**
(50% VMD+50% direct quarks)

[G. E. Brown, M. Rho, and W. Weise, Nucl. Phys. A 454, 669 (1986)]

Dileptons at SPS and RHIC

- radiation from **thermal sources**: **Hadronic many-body theory**

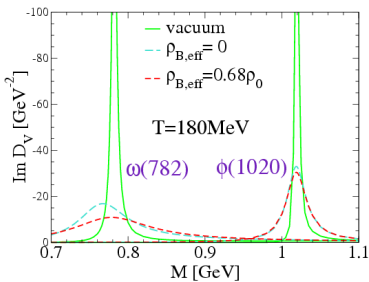
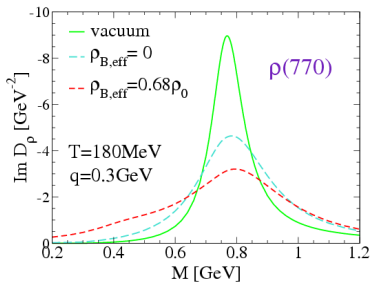

[R. Rapp, J. Wambach 99]

- baryon** effects important
- $n_B + n_{\bar{B}}$ relevant quantity (not net-baryon density)!

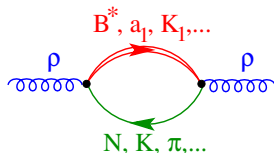
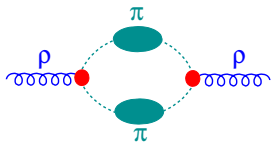

Dilepton rates: Hadron gas \leftrightarrow QGP

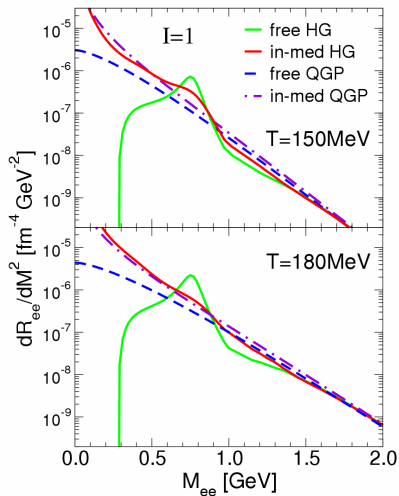

- in-medium **hadron gas** matches with **QGP**
- similar results also for γ rates
- “quark-hadron duality”!?
- consistent with **chiral-symmetry restoration**
- “**resonance melting**” rather than “dropping masses”

Sources of dilepton emission in heavy-ion collisions

- ① initial hard processes: Drell Yan
- ② “core” \Leftrightarrow emission from thermal source [McLerran, Toimela 1985]

$$\frac{1}{q_T} \frac{dN^{(\text{thermal})}}{dM dq_T} = \int d^4x \int dy \int M d\varphi \frac{dN^{(\text{thermal})}}{d^4x d^4q} \text{Acc}(M, q_T, y)$$

use cylindrical thermal fireball with QGP, mixed and hadronic phase

- ③ “corona” \Leftrightarrow emission from “primordial” mesons (jet-quenching)
- ④ after thermal freeze-out \Leftrightarrow emission from “freeze-out” mesons
[Cooper, Frye 1975]

$$N^{(\text{fo})} = \int \frac{d^3q}{q_0} \int q_\mu d\sigma^\mu f_B(u_\mu q^\mu / T) \frac{\Gamma_{\text{meson} \rightarrow \ell^+ \ell^-}}{\Gamma_{\text{meson}}} \text{Acc}$$

CERES/NA45 dielectron spectra

- good agreement also for **dielectron** spectra in 158 GeV Pb-Au
- **low-mass tail** from **baryon** effects

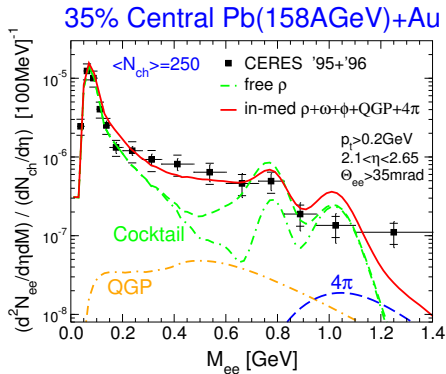
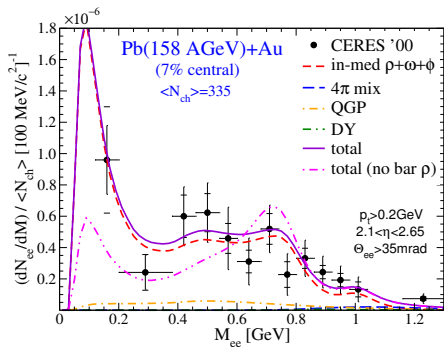

M spectra (in p_T slices)

- norm corrected by $\sim 3\%$ due to centrality correction
(min-bias data: $\langle N_{\text{ch}} \rangle = 120$, calculation $N_{\text{ch}} = 140$)

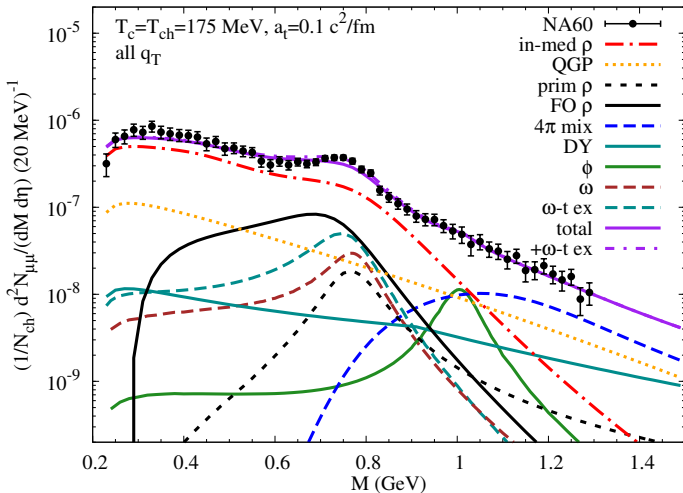

M spectra (in p_T slices)

- norm corrected by $\sim 3\%$ due to centrality correction
(min-bias data: $\langle N_{\text{ch}} \rangle = 120$, calculation $N_{\text{ch}} = 140$)

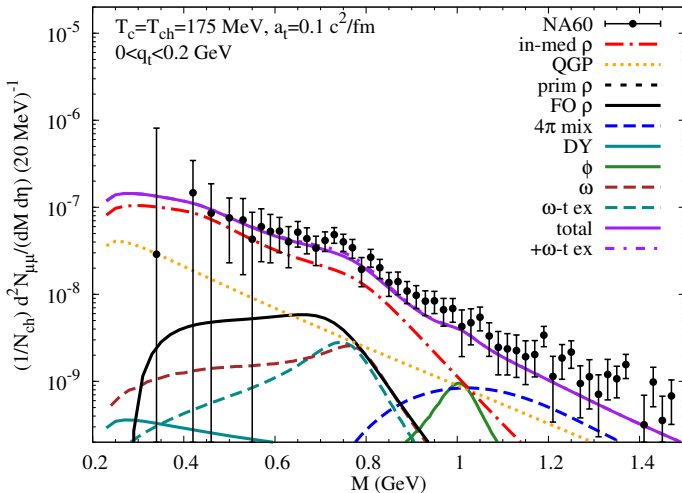

M spectra (in p_T slices)

- norm corrected by $\sim 3\%$ due to centrality correction
(min-bias data: $\langle N_{\text{ch}} \rangle = 120$, calculation $N_{\text{ch}} = 140$)

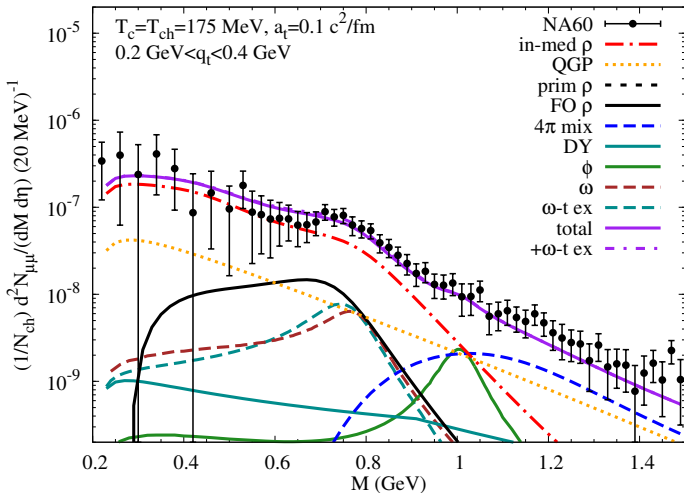

M spectra (in p_T slices)

- norm corrected by $\sim 3\%$ due to centrality correction
(min-bias data: $\langle N_{\text{ch}} \rangle = 120$, calculation $N_{\text{ch}} = 140$)

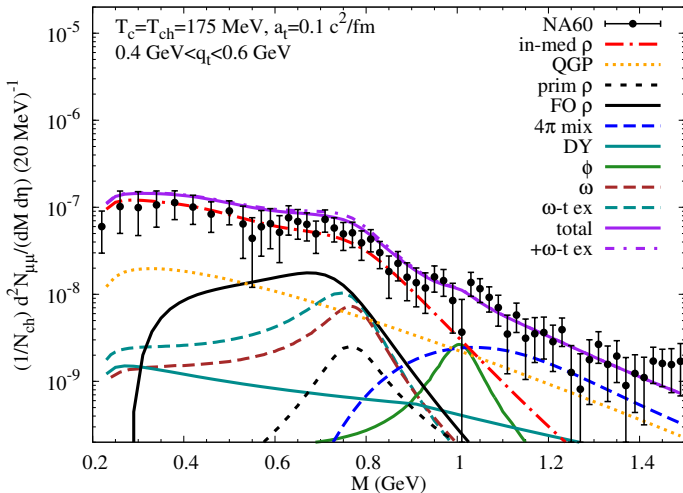

M spectra (in p_T slices)

- norm corrected by $\sim 3\%$ due to centrality correction
(min-bias data: $\langle N_{\text{ch}} \rangle = 120$, calculation $N_{\text{ch}} = 140$)

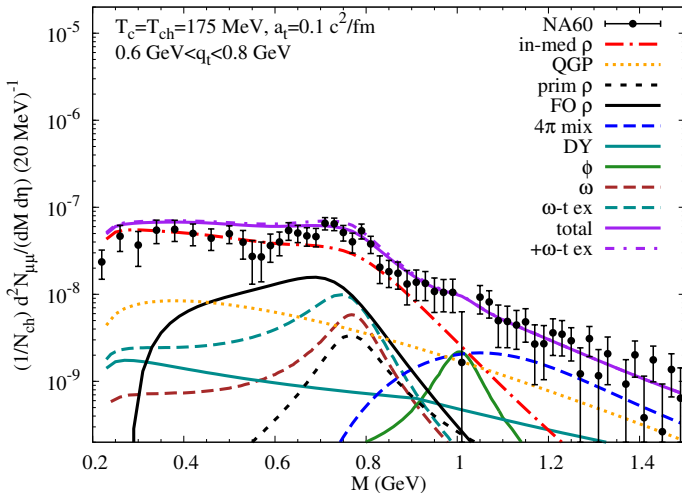

M spectra (in p_T slices)

- norm corrected by $\sim 3\%$ due to centrality correction
(min-bias data: $\langle N_{\text{ch}} \rangle = 120$, calculation $N_{\text{ch}} = 140$)

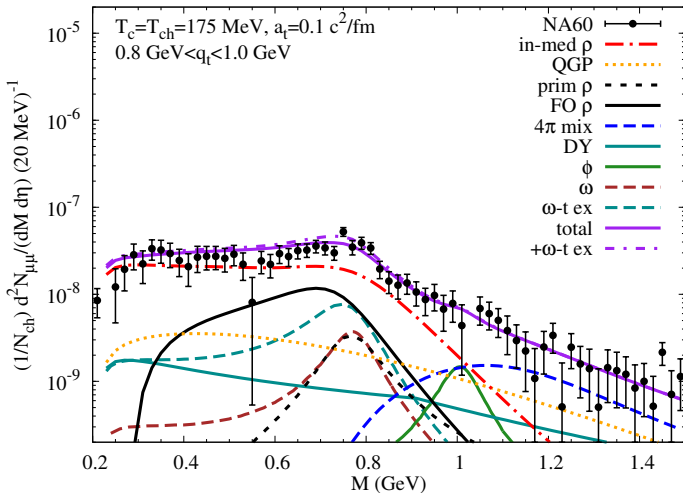

M spectra (in p_T slices)

- norm corrected by $\sim 3\%$ due to centrality correction
(min-bias data: $\langle N_{\text{ch}} \rangle = 120$, calculation $N_{\text{ch}} = 140$)

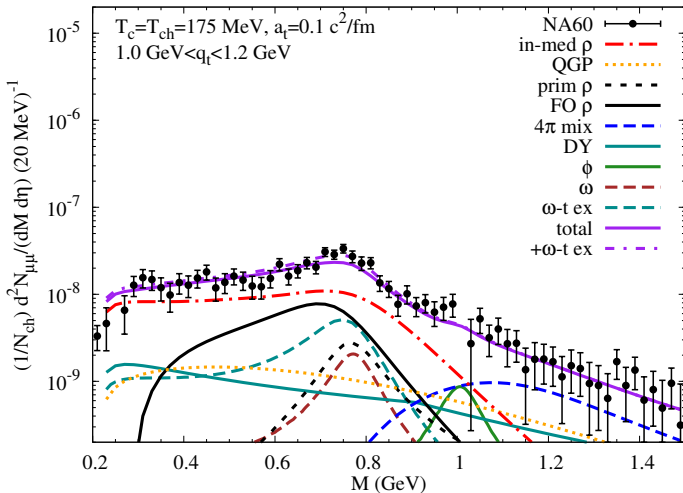

M spectra (in p_T slices)

- norm corrected by $\sim 3\%$ due to centrality correction
(min-bias data: $\langle N_{\text{ch}} \rangle = 120$, calculation $N_{\text{ch}} = 140$)

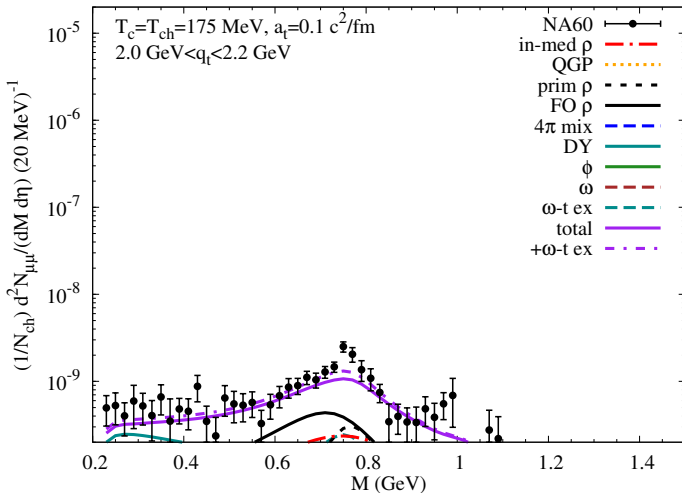

M spectra (in p_T slices)

- norm corrected by $\sim 3\%$ due to centrality correction
(min-bias data: $\langle N_{\text{ch}} \rangle = 120$, calculation $N_{\text{ch}} = 140$)

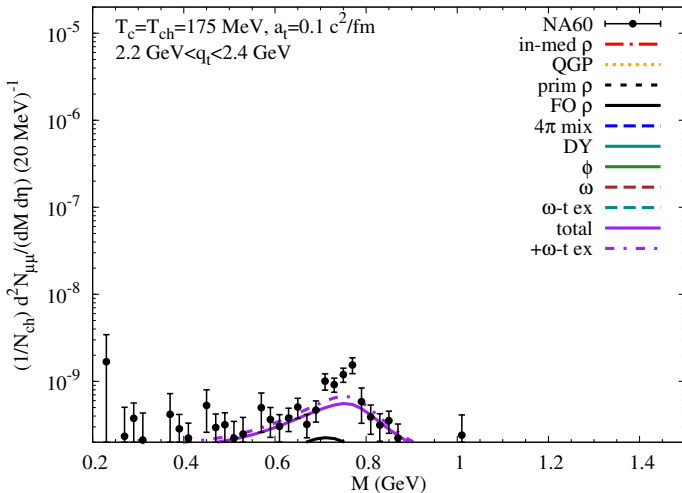

Importance of baryon effects

- baryonic interactions important!
- in-medium broadening
- low-mass tail!

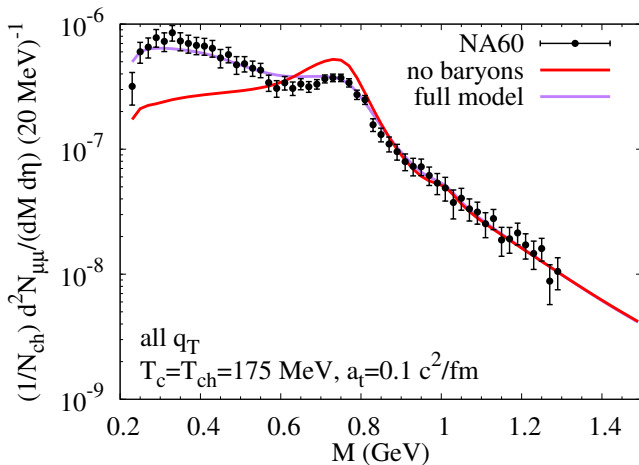

IMR: QGP vs. multi-pion radiation

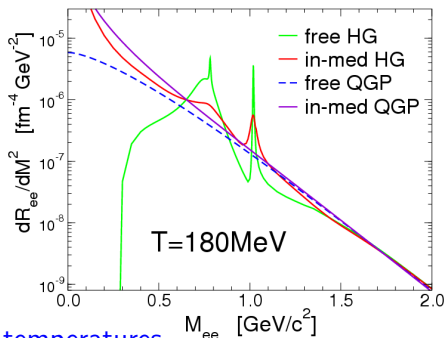
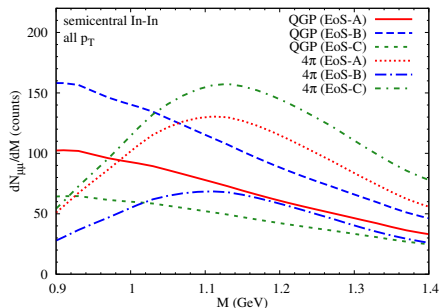

- different critical and freeze-out temperatures
 $T_c = 160 \dots 190 \text{ MeV}$, $T_{\text{chem}} = 160 \dots 175 \text{ MeV}$
- M - and p_T spectra comparably well described!
- reason: T vs. volume \Rightarrow maximal l^+l^- emission for
 $T = T_{\text{max}} = M/5.5$
- hadronic and partonic radiation “dual” for $T \sim T_c$
compatible with chiral-symmetry restoration!
- inconclusive whether **hadronic** or **partonic** emission in IMR!

Dileptons@RHIC: (Another) new Puzzle?

- huge enhancement in the LMR unexplained yet!

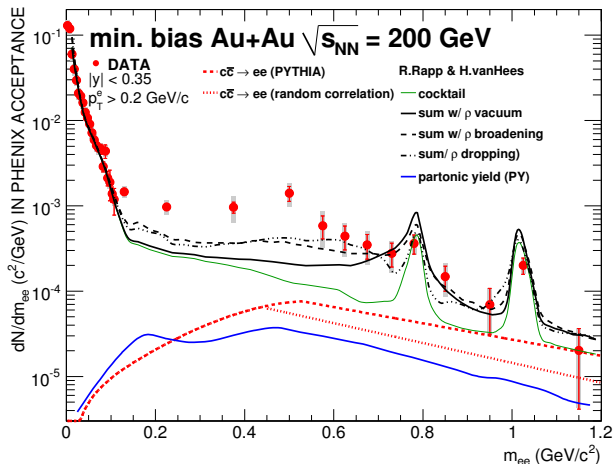

model: Rapp, HvH

[A. Adare et al (PHENIX), PRC **81**, 034911 (2010)]

Dileptons@RHIC: (Another) new Puzzle?

- huge enhancement in the LMR unexplained yet!

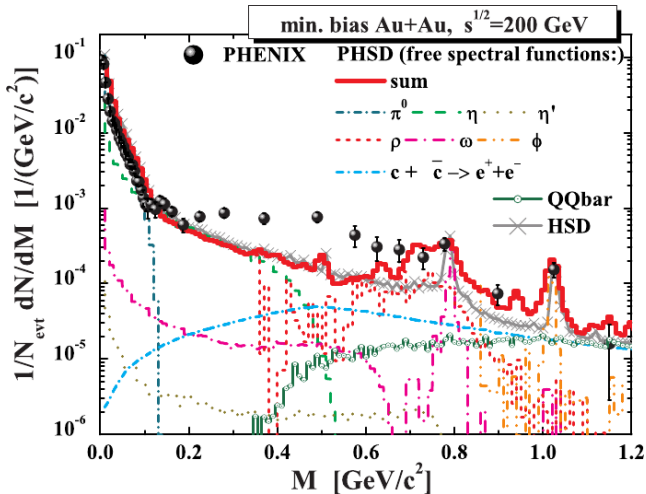

model: PHSD

[O. Linnyk, W. Cassing, E.L. Bratkovskaya, J. Manninen, NPA **855**, 273 (2011)]

Conclusions and Outlook

- dilepton spectra \Leftrightarrow in-medium em. current correlator
- SIS energies
 - dominated by bremsstrahlung and Dalitz decays
 - puzzle in OBE models (pp vs. pn)?
 - nucleon/ π form factors important bremsstrahlung
- SPS and RHIC energies
 - excess yield dominated by radiation from thermal sources
 - baryons essential for in-medium properties of vector mesons
 - melting vector mesons with little mass shift
 - IMR well described by scenarios with radiation dominated either by QGP or multi-pion processes (depending on EoS)
 - “quark-hadron duality” of $\ell^+\ell^-$ rates around T_c
 - compatible with chiral symmetry restoration!
 - new puzzle @ RHIC?!?
 - recent review:
R. Rapp, J. Wambach, HvH, Landolt-Börnstein, 1-23A
arXiv: 0901.3289 [hep-ph]